



**mitsubishi
electric**

AIR CONDITIONERS

Changes for the Better

Inverter Series
Mr. SLIM
R410A

52°C

Beat the Heat even at
High Temperatures







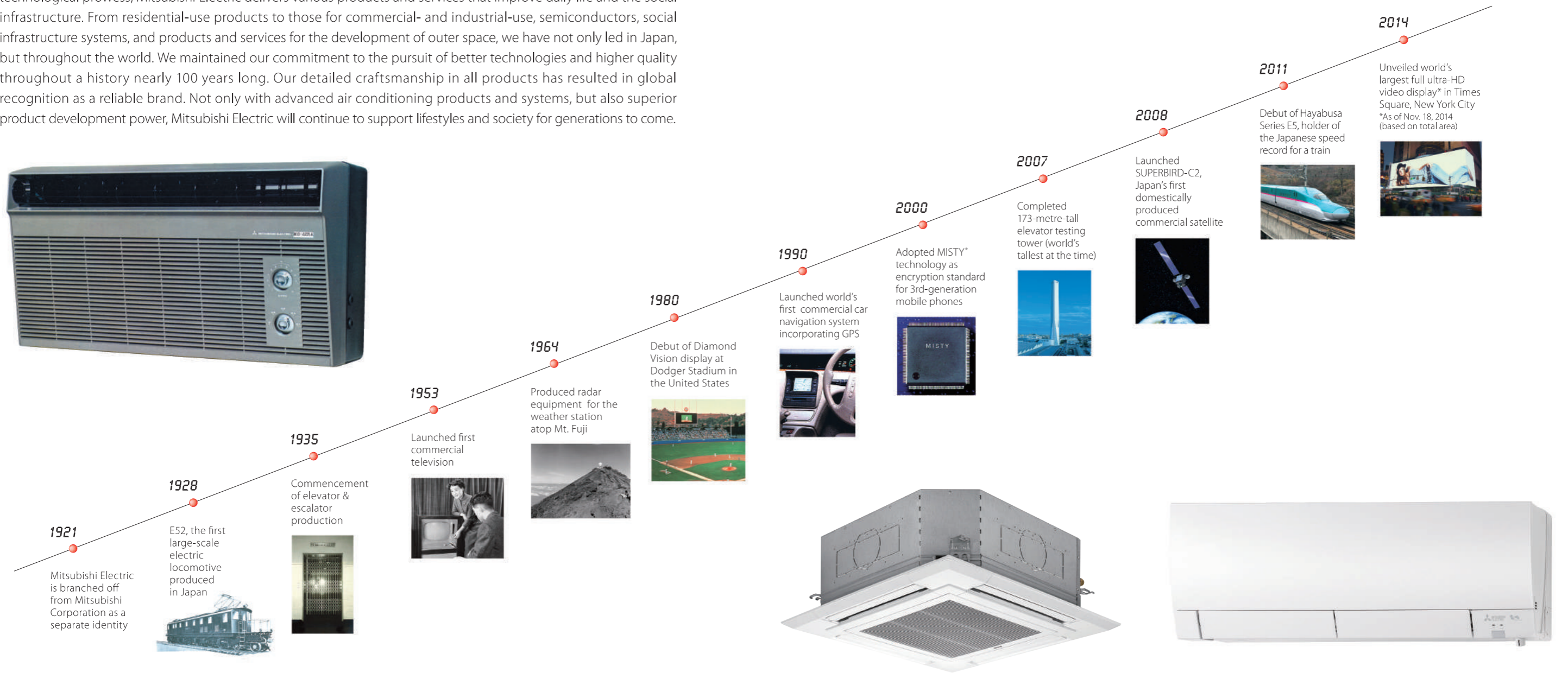





















Leading the world in every field with advanced technological prowess and assured quality

Technologies are forever changing society and the way people live. Applying innovative ideas and advanced technological prowess, Mitsubishi Electric delivers various products and services that improve daily life and the social infrastructure. From residential-use products to those for commercial- and industrial-use, semiconductors, social infrastructure systems, and products and services for the development of outer space, we have not only led in Japan, but throughout the world. We maintained our commitment to the pursuit of better technologies and higher quality throughout a history nearly 100 years long. Our detailed craftsmanship in all products has resulted in global recognition as a reliable brand. Not only with advanced air conditioning products and systems, but also superior product development power, Mitsubishi Electric will continue to support lifestyles and society for generations to come.



Air conditioner product history



		18,000 BTU/h	24,000 BTU/h	30,000 BTU/h	36,000 BTU/h	42,000 BTU/h	48,000 BTU/h	Remote Controller	Contents
	Ceiling-cassette (PLY-SP-EA SERIES)	 PLY-SP18EA	 PLY-SP24EA	 PLY-SP30EA	 PLY-SP36EA		 PLY-SP48EA	 PAR-SL100A-E For details of panel and controller, please refer to P.12	P. 10-14
	Ceiling-concealed (PEY-SP SERIES)	 PEY-SP18JA(L)2	 PEY-SP24JA(L)2	 PEY-SP30JA(L)2	 PEY-SP36JA(L)2		 PEY-SP48JA(L)2	  Optional PEY-SP.JA2wired remote controller PEY-SP.JAL2 ... wireless remote controller	P. 15-16
	Floor-standing (PSY-SP SERIES)				 PSY-SP36KA	 PSY-SP42KA	 PSY-SP48KA	 Built-in controller	P. 17-18
Outdoor Unit		 SUY-SA18VA2 SUY-SA18VA*	 SUY-SA24VA2 SUY-SA24VA*	 SUY-SA30VA2 SUY-SA30VA*	 PUY-SP36YKA2 PUY-SP36YKA*	 PUY-SP42YKA2 PUY-SP42YKA*	 PUY-SP48YKA2 PUY-SP48YKA*		

INVERTER TECHNOLOGIES

Mitsubishi Electric inverters ensure superior performance, including the optimum control of operation frequency. As a result, optimum power is applied in all heating/cooling ranges and maximum comfort is achieved while consuming minimal energy. Fast, comfortable operation and amazingly low running cost — That's the Mitsubishi Electric promise.

INVERTERS – HOW THEY WORK

Inverters electronically control the electrical voltage, current and frequency of electrical devices such as the compressor motor in an air conditioner. They receive information from sensors monitoring operating conditions and adjust the rotation speed of the compressor, which directly regulates air conditioner output. Optimum control of operation frequency results in eliminating the consumption of excessive electricity and providing the most comfortable room environment.

ECONOMIC OPERATION

Impressively low operating cost is a key advantage of inverter-equipped air conditioners. We have combined advanced inverter technologies with cutting-edge electronic and mechanical technologies to achieve a synergistic effect that enables improvements in heating/cooling performance efficiency. As a result, better performance and lower energy consumption are achieved.

TRUE COMFORT

Below is a simple comparison of air conditioner operation control with and without an inverter.

■ Inverter operation comparison

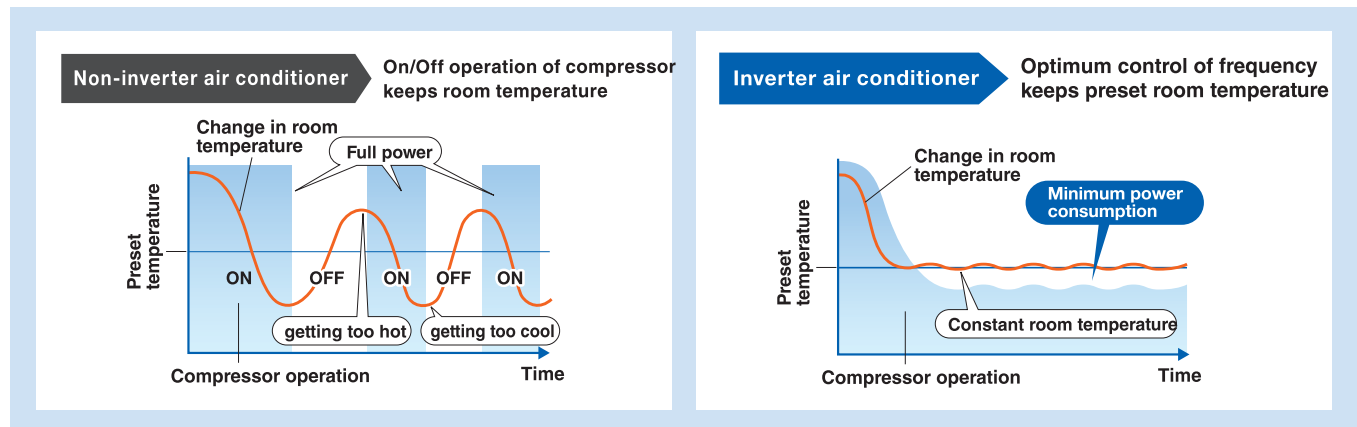

The compressors of air conditioners without an inverter start and stop repeatedly in order to maintain the preset room temperature. This repetitive on/off operation uses excessive electricity and compromises room comfort. The compressors of air conditioners equipped with an inverter run continuously; the inverter quickly optimizing the operating frequency according to changes in room temperature. This ensures energy-efficient operation and a more comfortable room.

Point 1 Quick & Powerful

Increasing the compressor motor speed by controlling the operation frequency ensures powerful output at start-up, and brings the room temperature to the comfort zone faster than units not equipped with an inverter. Hot rooms are cooled, and cold rooms are heated, faster and more efficiently.

Point 2 Room Temperature Maintained

The compressor motor operating frequency and the change in room temperature are monitored to calculate the most efficient waveform to maintain the room temperature in the comfort zone. This eliminates the large temperature swings common with non-inverter systems and guarantees a pleasant, comfortable environment.

R410A refrigerant

As scientific evidence points to man-made chemicals for the damage caused to the ozone layer, we only use chlorine-free refrigerants that are safe and rated zero ozone depletion potential (ODP). Accordingly, our systems require less energy to run and have significantly lower indirect global warming potential. In short, we produce the most efficient equipment possible, while helping to protect the environment.

The Montreal Protocol calls for the complete abolishment of HCFC refrigerant consumption in Article 5 countries (such as R22) by the year 2030.

Mitsubishi Electric is committed to shifting over to HFC models from HCFC models.

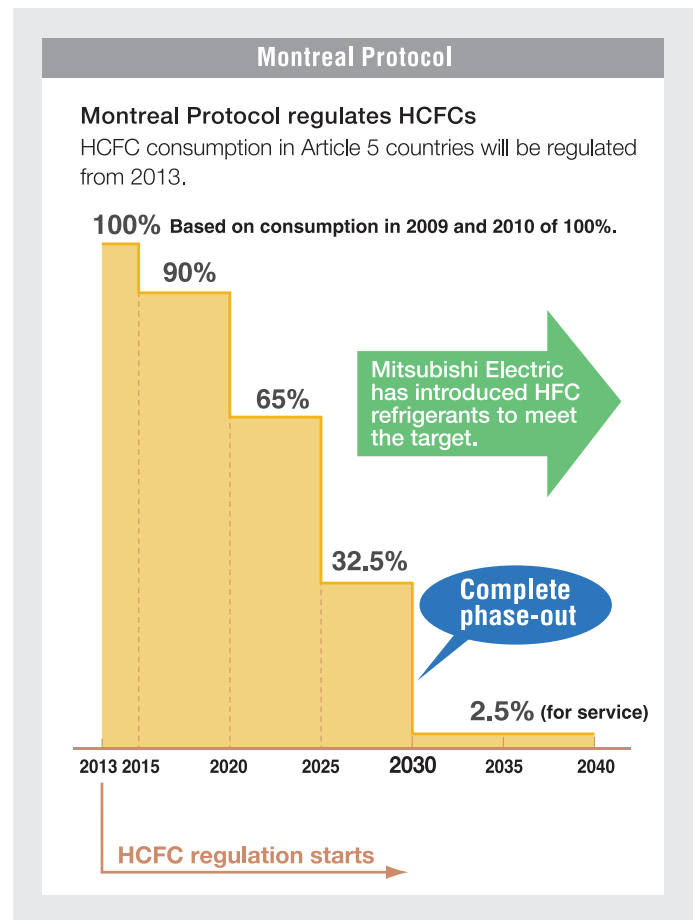

MITSUBISHI ELECTRIC Compressor

The compressor is the heart of the air conditioner. Employing MITSUBISHI ELECTRIC's proprietary technology, we are able to achieve both high efficiency and high power.



| Poki-Poki Motor

Dramatically enhanced motor efficiency utilising original dense winding technology. 28% more wire on compared to conventional motor



| Heat Caulking

Original heat caulking method minimizes cylinder distortion for even greater efficiency.

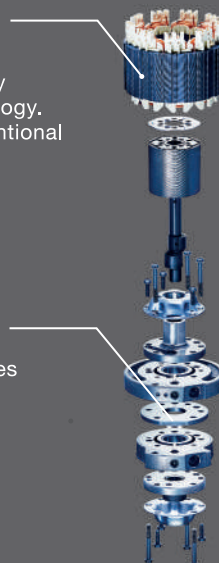

FUNCTIONS & TECHNOLOGIES

Category	Icon		P-Series								
			Indoor unit	PLY-SP18/24/30/36/42/48EA		PLY-SP-BA18/24/30/36/42/48BA		PEY-SP18/24/30/36/42/48JA(L)2		PSY-SP30/36/42/48KA	
				Outdoor unit	SUY-SA18/24/30VA2	PUY-SP36/42/48YKA2	SUY-SA18/24/30VA	PUY-SP36/42/48YKA	SUY-SA18/24/30VA2	PUY-SP36/42/48YKA2	SUY-SA30VA2
Technology	DC Inverter		●	●	●	●	●	●	●	●	
	Joint Lap DC Motor		●		●		●		●		
	Magnetic Flux Vector Sine Wave Drive			●		●		●		●	
	Heating Caulking (Compressor)		●		●		●		●		
	DC Fan Motor		●	●	●	●	●	●	●	●	
	Vector-Wave Eco Inverter			●		●		●		●	
	Pulse Amplitude Modulation (PAM)		●	●	●	●	●	●	●	●	
	Grooved Piping		●	●	●	●	●	●	●	●	
Energy Saving	3D i-see sensor		Opt	Opt							
	Area Temperature Monitor				Opt	Opt					
	Demand Function			Opt		Opt		Opt		Opt	
Air Quality	High-efficiency Filter		Opt	Opt	Opt	Opt					
	Long-life Filter		●	●	●	●			●	●	
	Filter Check Signal		●	●	●	●	●	●	●	●	
Air Distribution	Auto Vane		●	●	●	●			●	●	
	Horizontal Vane		●	●	●	●			●	●	
	Vertical Vane								●	●	
	High Ceiling Mode		●	●	●	●					
	Low Ceiling Mode		●	●	●	●					
	Auto Fan Speed Mode		●	●	●	●			●	●	
	Direct/Indirect Airflow (for Each Vane)		Opt	Opt							
Convenience	On/Off Operation Timer		●	●	●	●	●	●	●	●	
	Auto Restart		●	●	●	●	●	●	●	●	
	Low-noise Operation (outdoor unit)			●		●		●		●	
	Rotation, Back-up and 2nd Stage Cut-in Functions			Opt				Opt			
System Control	PAR-32MAA Control		Opt	Opt			Opt	Opt			
	Centralised On/Off Control		Opt	Opt	Opt	Opt	Opt	Opt	Opt	Opt	
	System Group Control		Opt	Opt	Opt	Opt	Opt	Opt	Opt	Opt	
	M-NET Connection		Opt	Opt	Opt	Opt	Opt	Opt	Opt	Opt	
Installation	Cleaning-free Pipe Reuse		●*	●	●*	●	●*	●	●*	●	
	Reuse of Existing Wiring			Opt		Opt		Opt		Opt	
	Drain Pump		●	●	●	●	Opt	Opt			
	Pump Down Switch			●		●		●		●	
	Flare Connection		●	●	●	●	●	●	●	●	
Maintenance	Self-Diagnostic Function (Check Code Display)		●	●	●	●	●	●	●	●	
	Failure Recall Function		●	●	●	●	●	●	●	●	

● Opt: Separate parts must be purchased.
*Not available for different diameter joints.

Joint Lap DC Motor

Mitsubishi Electric has developed a unique motor, called the "Poki-Poki Motor" in Japan, which is manufactured using a joint lapping technique. This innovative motor operates based on a high-density, high-magnetic force, leading to extremely high efficiency and reliability.

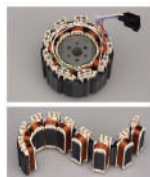

Magnetic Flux Vector Sine Wave Drive

This drive device is actually a microprocessor that converts the compressor motor's electrical current waveform from a conventional waveform to a sine wave (180°conductance) to achieve higher efficiency by raising the motor winding utilisation ratio and reducing energy loss.

Heat Caulking Fixing Method

To fix internal parts in place, a "Heat Caulking Fixing Method" is used, replacing the former arc spot welding method. Distortion of internal parts is reduced, realising higher efficiency.



DC Fan Motor

A highly efficient DC motor drives the fan of the outdoor unit. Efficiency is much higher than an equivalent AC motor.

Vector-Wave Eco Inverter

This inverter monitors the varying compressor motor frequency and creates the most efficient waveform for the motor speed. As the result, operating efficiency in all speed ranges is improved, less power is used and annual electricity cost is reduced.

Smooth wave pattern

Inverter size has been reduced using insert-molding, where the circuit pattern is molded into the synthetic resin. To ensure quiet operation, soft PWM control is used to prevent the metallic whine associated with conventional inverters.

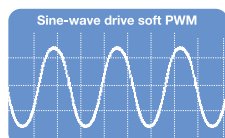

PAM (Pulse Amplitude Modulation)

PAM is a technology that controls the current waveform so that it resembles the supply voltage wave, thereby reducing loss and realising more efficient use of electricity. Using PAM control, 98% of the input power supply is used effectively.

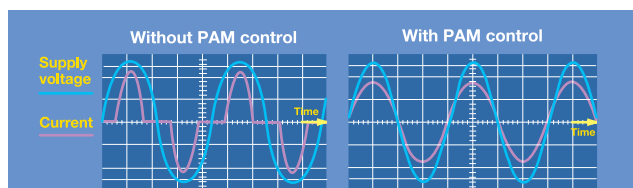

PAM adjusts the form of the current wave so that it becomes close to that of the supply voltage wave. High harmonics are reduced and 98% of the electricity is utilized.

Merits of PAM Control

Significant energy savings
Remarkable reduction in power loss saves electricity

Power increased
Efficient voltage increase realises increased power

Limited energy savings
Electricity is wasted

Limited power
Insufficient power when needed

PAM

Conventional inverter

Grooved Piping

High-performance grooved piping is used in heat exchangers to increase the heat exchange area.

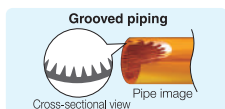

Pure White

Pure white is adopted for the unit colour; white expressing the essence of cleanliness and easily matching virtually all interior décor.

Horizontal Vane

The air outlet vane swings up and down so that the airflow is spread evenly throughout the room.

Vertical Vane*

*Condition apply
The air outlet fin swings from side to side so that the airflow reaches every part of the room.

On/Off Operation Timer

Use the remote controller to set the times of turning the air-conditioner On/Off.

Auto Restart

Especially useful at the time of power outages, the unit turns back on automatically when power is restored.

Demand Function (Onsite Adjustment)

The demand function can be activated when the unit is equipped with a commercially available timer or an On/Off switch is added to the CNDM connector (option) on the control board of the outdoor unit. Energy consumption can be reduced up to 100% of the normal consumption according to the signal input from outside.

[Example: PUY Series]

Limit energy consumption by changing the settings of SW7-1, SW2 and SW3 on the control board of the outdoor unit. The following settings are possible.

SW7-1	SW2	SW3	Energy consumption
ON	OFF	OFF	100%
	ON	OFF	75%
	ON	ON	50%
	OFF	ON	0% (Stop)

*PUY outdoor only

Long-life Filter

A special process for the entrapment surface improves the filtering effect, making the maintenance cycle longer than that of units equipped with conventional filters.

Filter Check Signal

Air conditioner operating time is monitored, and the user is notified when filter maintenance is necessary.

High Ceiling Mode

In the case of rooms with high ceilings, the outlet-air volume can be increased to ensure that air is circulated all the way to the floor.

Low Ceiling Mode

If the room has a low ceiling, the airflow volume can be reduced for less draft.

Auto Fan Speed Mode

The airflow speed mode adjusts the fan speed of the indoor unit automatically according to the present room conditions.

Drain Pump

A built-in drain pump enables drain piping to be raised.

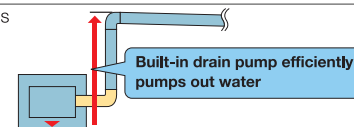

Self-Diagnostic Function (Check Code Display)

Check codes are displayed on the remote controller or the operation indicator to inform the user of malfunctions detected.

Failure Recall Function

Operation failures are recorded, allowing confirmation when needed.

MAJOR FEATURES

■ Operating at high temperatures (52°C)

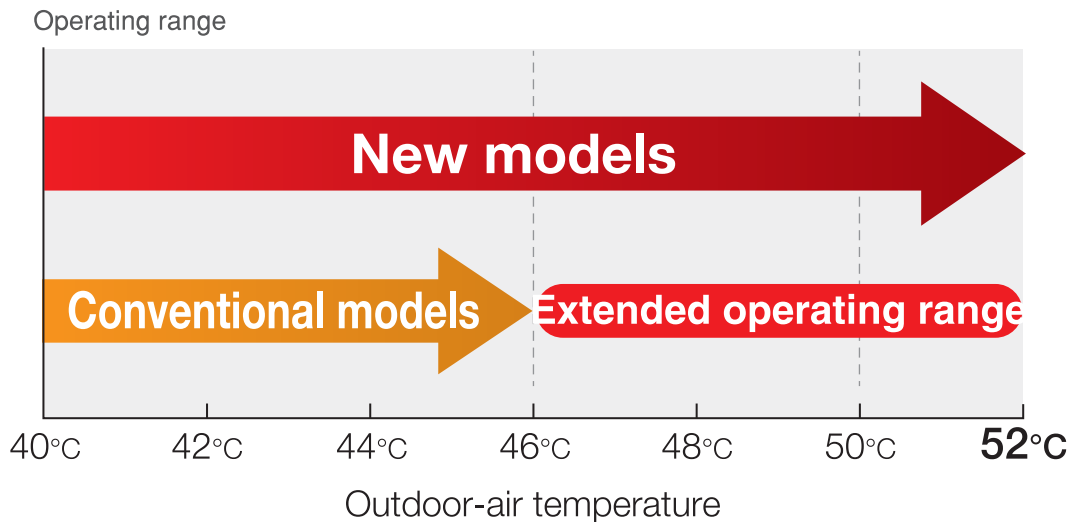

New inverter technology

New inverter technology has made it possible for units to operate at outdoor-air temperatures as high as **52°C**. Tropical Specification series units are perfect for cooling homes and offices in tropical regions.

High dehumidifying capacity

Prevent the decrease of dehumidifying capacity even when the room temperature approaches the preset temperature since outdoor units detect and control evaporating temperature.

New R410A lineup

From low-capacity 18,000Btu to high-capacity 48,000Btu units available, the new models in the R410A Series have highest I SEER in industry compared with conventional non-inverter models. All models contribute to reducing energy consumption over a wide range of operating capacities.

4-way Ceiling-cassette

(PLY-SP-EA SERIES)



PLY-SP18/24/30/36/48EA

(3D i-see Sensor: optional)



4 Star



A sophisticated design that matches a variety of rooms and a high level of convenience enhancing your quality of life are combined in this compact, multi-functional indoor unit.

Beautiful square design

The beautiful design harmonizes with any interior, making it ideal for facilities such as offices and retail stores.

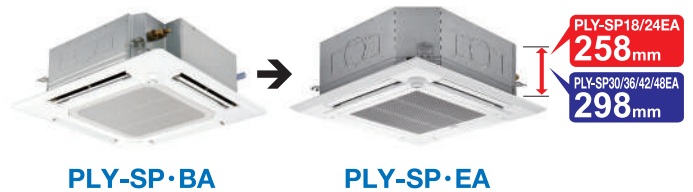

"Pure White" Colour Matches Interior Décor

The colour "Pure White" has been introduced for the decoration panel and wired remote controller so as to blend in with any interior décor.

3D Turbo Fan ~ Quiet operation

An improved airflow path and powerful high-capacity flow fan contribute to the realisation of quieter operation.



3 D turbo fan

3D i-see Sensor (optional)



The "3D i-see Sensor" built into the optional corner panel eliminates uneven temperature distribution and reduces electricity consumption.

Highly accurate motion detection

A total of eight sensors rotate a full 360° in 3-minute intervals. In addition to detecting body temperature, our original algorithm also detects the number of occupants in the room and their positions.

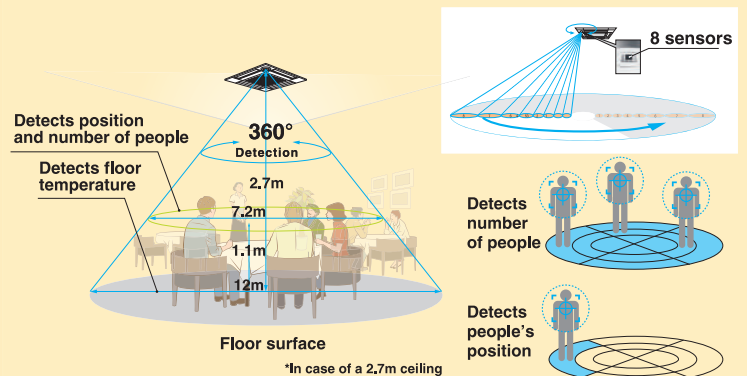

"3D i-see Sensor" temperature-sensing technology improves energy efficiency and enhances room comfort

The "3D i-see Sensor" is an innovative Mitsubishi Electric technology that uses a radiation-based sensor to monitor temperature throughout an entire room. When connected to the air conditioner control panel, the "3D i-see Sensor" works to maximize room comfort.

Sensible temperature control prevents excessive cooling through pioneering control technology

By measuring the inlet temperature and floor temperature, temperatures felt by the human body (sensible temperature) are computed. This allows the proper sensible temperature to always be maintained through the suppression of excessive cooling.



Detects number of people

Room occupancy energy-saving mode

The 3D i-see Sensor detects the number of people in the room. It then calculates the occupancy rate based on the maximum number of people in the room up to that point in time in order to save air-conditioning power. When the occupancy rate is approximately 30%, air-conditioning power equivalent to 1°C during cooling operation is saved. The temperature is controlled according to the number of people.

Room occupancy energy save mode



30%
1°C power savings

No occupancy energy save mode

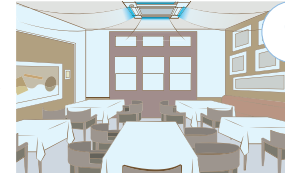

0%
2°C power savings

No occupancy Auto-Off mode



0%
Auto-Off

*PAR-32MAA is required for each setting
**% is room occupancy rate.

No occupancy energy-saving mode

When 3D i-see Sensor detects that no one is in the room, the system is switched to a pre-set power-saving mode. If the room remains unoccupied for more than 60min, air-conditioning power equivalent to 2°C during cooling operation is saved. This contributes to preventing waste in terms of cooling.

No occupancy Auto-OFF mode

When the room remains unoccupied for a pre-set period of time, the air conditioner turns off automatically, thereby providing even greater power savings. The time until operation is stopped can be set in intervals of 10min, ranging from 60 to 180 min.

Detect people's position

Direct/Indirect settings*

Some people do not like the feel of wind, some want to be warm from head to toe. People's likes and dislikes vary. With the 3D i-see Sensor, it is possible to choose to block or not block to the wind for each vane.

*PAR-32MAA or PAR-SL100A-E is required for each setting.

Direct (Downward)



Indirect (Horizontal)



Saves energy while keeping a comfortable effective temperature by automatically switching between ventilation and cooling. When a pre-set temperature is reached, the air conditioning unit switches to swing fan operation to maintain the effective temperature. This clever function contributes to keeping a comfortable coolness.

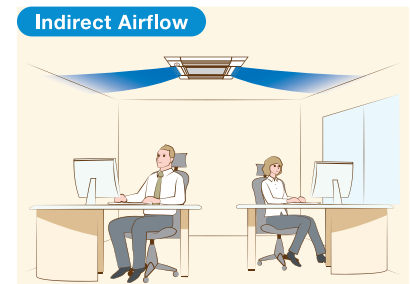
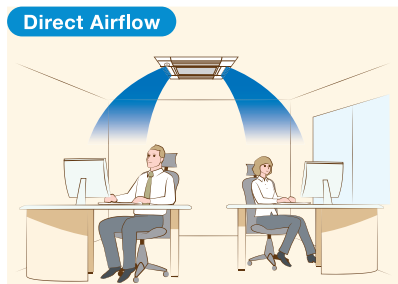

*Only available for models equipped with 3D i-see Sensor.

Cooling	Vane setting	
	Direct	Indirect
	horizontal → swing	keep horizontal

Vane Control Applications

For Shopping Malls

Wide airflow coverage down to the floor even in expansive spaces like large factory-outlet centers or shopping malls with high ceilings.

The unique airflow design of the powerful ceiling-cassette models reduces pressure loss and provides wide cool-air coverage from high ceilings to the floor even in expansive spaces like shopping malls with ceilings over 4 metres in height.

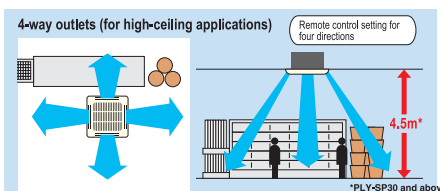

For Retail Outlets (e.g. grocery stores)

These units are ideal for maintaining constant temperatures in environments that have equipment such as refrigerated showcases.

Individual vane angle adjustment enables precise airflow control to specific areas of the store to reduce unnecessary air conditioning of areas such as refrigerated showcases.

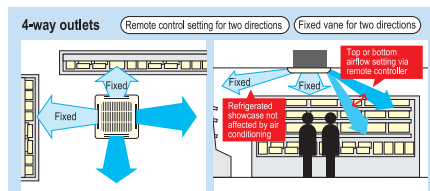

For Offices

Flexible and pleasant airflow eliminates annoying drafts within the office environment.

In office environments, annoying drafts can be bothersome, leading to discomfort and reduced productivity. Precise vane control helps to eliminate this problem.

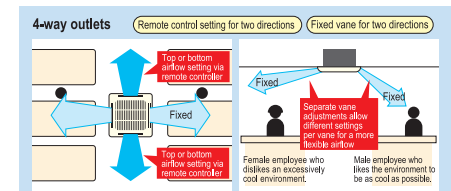

Remote controller for PLY-SP-EA

Features (PAR-SL100A-E)

Wireless Remote Controller PAR-SL100A-E

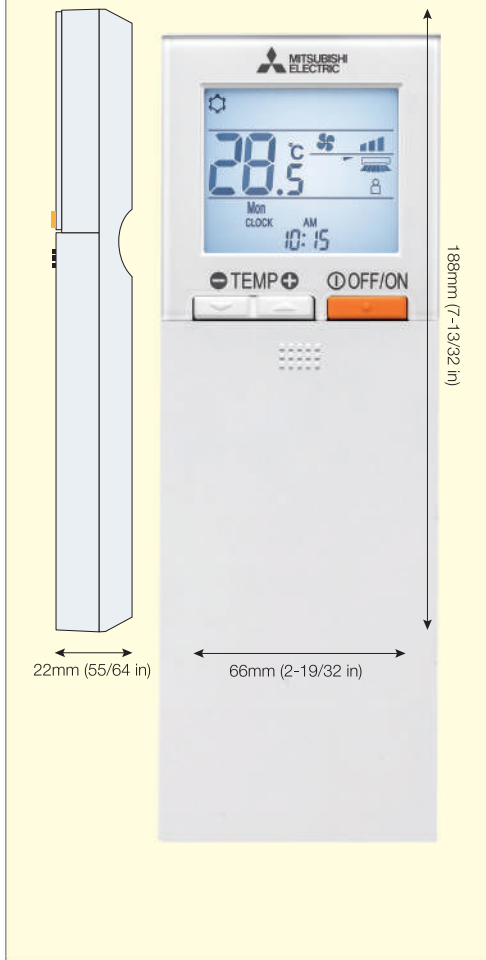

3D i-see Sensor (Optional)

(Direct/Indirect Airflow)
Pressing the i-see button enables direct or indirect setting of all vanes.

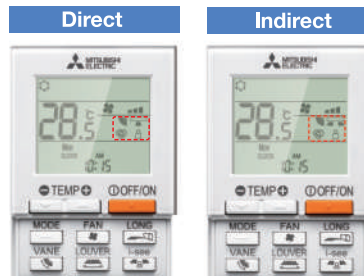

Weekly Timer

The Weekly Timer enables the setting of operation start and stop times and adjusting the temperature as standard features.



Backlight

Backlight function incorporated, making screen easy to read in the dark. Even in dimly lit rooms, the screen can be seen clearly for trouble-free remote controller operation.



Battery Replacement Indicator

Previous wireless remote controllers were not able to check when the battery was low. Beginning with the PAR-SL100A-E, a battery charge indicator that shows the charge status is included in the LCD so it can be seen when the battery is low and needs to be changed.



Individual Vane Settings

The airflow directions of the four vanes can each be adjusted independently. Easily set the optimum airflow according to the room setting.

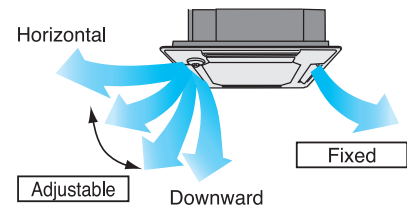

Note : PAR-SL100A-E can be used with only PLY-SP-EA series.

Panel and remote controller

Part model name	Description	Included parts						
		Standard panel	Wireless signal receiver	3D i-see sensor	Wired controller (PAR-21MAA)	Wired controller (PAR-32MAA)	Wireless controller (PAR-SL97A-E)	Wireless controller (PAR-SL100A-E)
PLP-6EA	Standard panel only	✓						
PLP-6EALCM	Panel with receiver and wireless remote controller (SL97)	✓	✓				✓	
PLP-6EALM	Panel with receiver and wireless remote controller (SL100)	✓	✓					✓
PAC-SE1ME-E	3D i-see sensor corner panel			✓				
PAR-SE9FA-E	Wireless signal receiver only		✓					
PAR-SL97A-E	Wireless remote controller only						✓	
PAR-SL100A-E	Wireless remote controller only							✓
PAR-21MAA	Wired remote controller only				✓			
PAR-32MAA	Wired remote controller only					✓		

Easy Installation and Maintenance

Electrical box wiring

After reviewing the power supply terminal position in the electrical box, the structure was redesigned to improve connectivity. This has made previously complex wiring work easier.

■ Previous model (B Series)

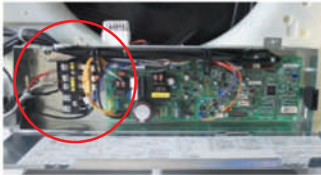

■ New model (E Series)

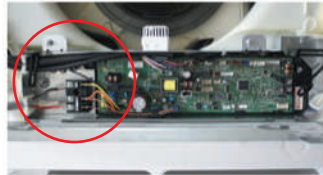

Increased space for plumbing work

The top and bottom positions of the liquid and gas pipes have been reversed to allow the gas pipe work, which requires more effort, to be completed first. Further, through structural innovations related to the space around the pipes, the area where the spanner can be moved has been increased, thus improving liquid pipe work and enabling it to be completed smoothly.

■ Previous model (B Series)

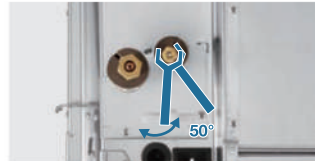

■ New model (E Series)



Temporary hanging hook

The structure of the panel has been revised and is now equipped with a temporary hanging hook. This has improved work efficiency during panel installation.



No need to remove screws

Installation is possible without removing the screws for the corner panel and the control box, simply loosen them. This lowers the risk of losing screws.

■ Corner panel



■ Control box cover



Lightweight decorative panel

After reviewing the structure and materials, weight has been reduced approximately 20% compared to the previous model, reducing the burden of installation.

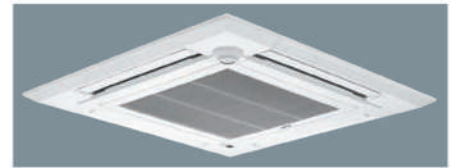

Handy Corner Pocket Design Simplifies Maintenance

By using the handy pockets equipped on the four corners of the grille, maintenance work such as drain pan cleaning and height adjustments can be accomplished without removing the grille.



Drain Water Lifting Mechanism

A high-performance drain pump on the drain water lifting mechanism allows the drain water pipe to be routed as high as 850mm from the ceiling surface.

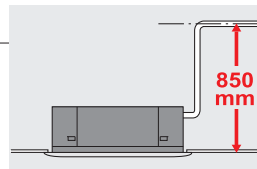

Bacteria-resistant Filters

Mitsubishi Electric filters are bacteria-resistant and designed for fresh and pleasant air conditioning at all times.

Features at a glance

Installation & Maintenance	Comfort	Others
• Chargeless system	• 3D i-see Sensor	• System control
• Compact design	• Auto fan speed	• Auto vane shutter
• Drain water lifting (850mm)	• Wide vane	• Auto restart
• Handy corner pocket	• Smudge/draft-free	• Outdoor unit max. operating temp. of 52°C
• Long-life filter (2500hr)*	• High-ceiling application	
• Self-diagnostic function	• Computerized dehumidifier	
• Filter indicator (for wired remote controller)	• Quiet operation	
• Flockless vanes	• Bacteria- and mold-resistant filter	

*May vary according to operating conditions.

SPECIFICATIONS

4-way Ceiling Cassette (50Hz) PLY-SP-EA Series

Models		PLY-SP18EA	PLY-SP24EA	PLY-SP30EA	PLY-SP36EA	PLY-SP48EA	
Cooling capacity (Min-Max)	kW	5.3 (2.8-5.3)	7.1 (2.9-7.1)	8.8 (4.1-8.8)	10.6 (4.0-10.6)	14.1 (7.0-14.1)	
Cooling capacity	BTU/h	18,000	24,000	30,000	36,000	48,000	
Total input	kW	1.60	2.17	2.48	3.52	6.02	
EER	W/W	3.31	3.27	3.54	3.01	2.34	
ISEER	W/W	4.50	4.50	4.50	4.30	3.54	
Model name		PLY-SP18EA	PLY-SP24EA	PLY-SP30EA	PLY-SP36EA	PLY-SP48EA	
Indoor unit	Power supply	1ph 220-240V 50Hz			1ph 220-240V 50Hz	1ph 220-240V 50Hz	
	External finish	Munsell 1.0Y 0.2/9.2			Munsell 1.0Y 0.2/9.2	Munsell 1.0Y 0.2/9.2	
	Airflow (low-med2-med1-high)	CMM	16-17-19-21	16-18-21-23	19-23-26-29	21-25-28-31	24-26-29-32
		CFM	565-600-670-740	565-635-740-810	670-810-920-1025	740-885-990-1095	850-920-1025-1130
	External static pressure	Pa	0 (direct blow)			0 (direct blow)	0 (direct blow)
	Operation control and thermostat	Remote-control & Built-in			Remote-control & Built-in	Remote-control & Built-in	
	Noise level (low-med2-med1-high)	dB (A)	28-30-32-35	28-31-34-37	31-34-37-41	32-37-41-43	36-39-42-44
	Unit drain pipe (outer diameter)	mm	32			32	32
	Dimensions (panel)	W	840 (950)			840 (950)	840 (950)
		D	840 (950)			840 (950)	840 (950)
H		258 (40)			298 (40)	298 (40)	
Weight (panel)	kg	21 (5)		24 (5)	27 (5)	27 (5)	
Model name		SUY-SA18VA2	SUY-SA24VA2	SUY-SA30VA2	PUY-SP36YKA2	PUY-SP48YKA2	
Power supply		1ph 220-240V 50Hz			3ph 380-415V 50Hz	3ph 380-415V 50Hz	
External finish		Munsell 3.0Y 7.8/1.1			Munsell 3.0Y 7.8/1.1	Munsell 3.0Y 7.8/1.1	
Refrigerant (R410A) control		Linear expansion valve			Linear expansion valve	Linear expansion valve	
Airflow	CMM	27	46	51	75	87	
	CFM	953	1625	1800	2648	3071	
Noise level	dB (A)	47	52	54	52	56	
Dimensions	W	800			1050	1050	
	D	285			330	330	
	H	550			981	981	
Weight	kg	32	49	50	65	73	
Max. height difference	m	12	15	15	30	30	
Max. piping length	m	20	30	30	50	50	
Pipe size (outer diameter)	mm	Liquid: 6.35 Gas: 12.7	Liquid: 9.52 Gas: 15.88		Liquid: 9.52 Gas: 15.88	Liquid: 9.52 Gas: 15.88	
Guaranteed Operating Range	Upper limit (DB)	52			52	52	
	Lower limit (DB)	18			18	18	
BEE Star Rating				—	—		

- Refrigerant piping length (one-way): 7.5m(25ft)
- Rating conditions Cooling - Indoor: 27°C (80°F)DB, 19°C (66°F)WB, Outdoor: 35°C (95°F)DB

Ceiling-concealed

(PEY-SP SERIES)

The thin, ceiling-concealed indoor units of the PEY series are the perfect answer for the air-conditioning requirements of buildings with minimum ceiling installation space and wide-ranging external static pressure. Energy-saving efficiency has been improved, thereby reducing electricity consumption and contributing to a further reduction in operating cost.

Compact Indoor Units

For all models, unit height is unified to 250mm. Compared to the previous model, height has been reduced, allowing installation in tight spaces such as ceiling cavities or drop-ceilings.

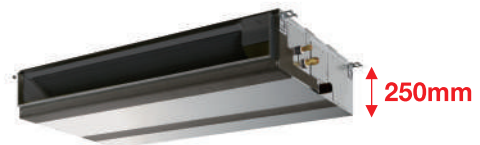

PEY-SP18/24/30/36/48JA(L)2

PEY-SP-JA2 wired remote controller
PEY-SP-JAL2 wireless remote controller



optional optional

(1) Rear inlet

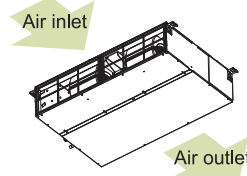

(2) Bottom inlet

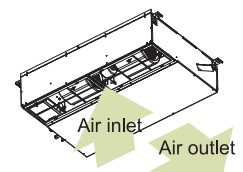

Wide Selection of Fan Speeds and External Static Pressure

Five-stage external static pressure conversions and three fan speed selections are available. Capable of being set to a maximum of 125Pa, units are applicable to a wide range of building types.

n External static pressure setting

Series	18	24	30	36	42	48
PEY-SP-JA(L)2	35/50/70/100/125Pa					

n Flexible duct design

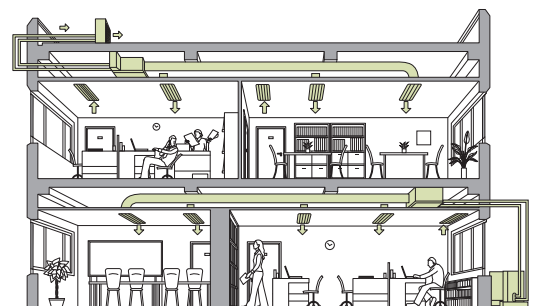

Features at a glance

Installation & Maintenance	Comfort	Others
<ul style="list-style-type: none"> • Chargeless system • Smooth installation • Self-diagnostic function 	<ul style="list-style-type: none"> • Computerized dehumidifier • Quiet operation 	<ul style="list-style-type: none"> • System control • Auto restart • Outdoor unit max. operating temp. of 52°C
<ul style="list-style-type: none"> • Drain pump (optional) 		

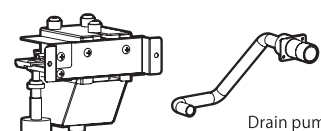

Drain pump (optional)



SPECIFICATIONS

Ceiling Concealed (50Hz)

PEY-SP SERIES

Models		PEY-SP18JA(L)2	PEY-SP24JA(L)2	PEY-SP30JA(L)2	PEY-SP36JA(L)2	PEY-SP48JA(L)2	
Cooling capacity (Min-Max)	kW	5.3 (2.8-5.3)	7.1 (2.9-7.1)	8.8 (3.8-8.8)	10.6 (4.0-10.6)	14.1 (7.0-14.1)	
Cooling capacity	BTU/h	18,000	24,000	30,000	36,000	48,000	
Total input	kW	1.72	2.16	2.50	3.66	5.73	
EER	W/W	3.08	3.28	3.52	2.90	2.46	
Indoor unit	Model name	PEY-SP18JA(L)	PEY-SP24JA(L)	PEY-SP30JA(L)	PEY-SP36JA(L)	PEY-SP48JA(L)	
	Power supply	1ph 220-240V 50Hz			1ph 220-240V 50Hz	1ph 220-240V 50Hz	
	External finish	Galvanized sheet	Galvanized sheet	Galvanized sheet	Galvanized sheet	Galvanized sheet	
	Airflow (low-mid-high)	CMM	12-14.5-17	17.5-21-25	24-29-34	29.5-35.5-42	29.5-35.5-42
		CFM	425-510-600	620-740-885	850-1025-1200	1040-1225-1485	1040-1225-1485
	External static pressure	Pa	35-50-70-100-125			35-50-70-100-125	35-50-70-100-125
	Operation control and thermostat	Remote control and Built-in			Remote control and Built-in	Remote control and Built-in	
	Noise level (low-med-high)	dB (A)	30-35-39	30-34-39	33-38-42	36-40-44	36-40-44
	Unit drain pipe (outer diameter)	mm	32			32	32
	Dimensions	W	mm	900	1100	1400	1400
		D	mm	732	732	732	732
H		mm	250	250	250	250	
Weight (panel)	kg	27	29	38	39	39	
Outdoor unit	Model name	SUY-SA18VA2	SUY-SA24VA2	SUY-SA30VA2	PUY-SP36YKA2	PUY-SP48YKA2	
	Power supply	1ph 220-240V 50Hz			3ph 380-415V 50Hz	3ph 380-415V 50Hz	
	External finish	Munsell 3.0Y 7.8/1.1			Munsell 3.0Y 7.8/1.1	Munsell 3.0Y 7.8/1.1	
	Refrigerant (R410A) control	Linear expansion valve			Linear expansion valve	Linear expansion valve	
	Airflow	CMM	27	46	51	75	87
		CFM	953	1625	1800	2648	3071
	Noise level	dB (A)	47	52	54	52	56
	Dimensions	W	mm	800	840	1050	1050
		D	mm	285	330	330	330
		H	mm	550	880	981	981
	Weight	kg	32	49	50	65	73
Max. height difference	m	12	15	15	30	30	
Max. piping length	m	20	30	30	50	50	
Pipe size (outer diameter)	mm	Liquid: 6.35 Gas: 12.7	Liquid: 9.52 Gas: 15.88		Liquid: 9.52 Gas: 15.88	Liquid: 9.52 Gas: 15.88	
Guaranteed Operating Range	Upper limit (DB)	52			52	52	
	Lower limit (DB)	18			18	18	

• Rating conditions Cooling - Indoor: 27°C (80°F)DB, 19°C (66°F)WB, Outdoor: 35°C (95°F)DB

• Refrigerant piping length (one-way): 7.5m(25ft)

Floor-standing

(PSY SERIES)



PSY-SP36/42/48KA



Built-in controller



Installation of this floor-standing series is easy and quick. An excellent choice when there is a sudden need for an air conditioner to be installed.

Quick and Easy Installation, Space-saving and Design That Compliments Any Interior

The floor-standing indoor unit is mounted on the floor, enabling quick installation. Its compact body requires only minimal space.

PSY-SP30/36/42/48KA

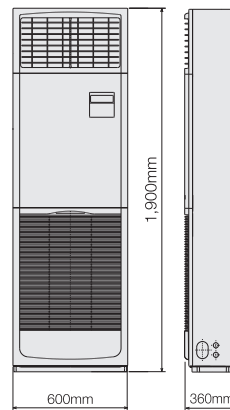

4-way pipe work connections enable greater freedom in installation

Remarkable freedom in choosing installation sites is allowed by providing piping connection to the indoor unit in four places: left side, back, from underneath and on the right side of the unit. Even installation in the corner of a room is easy.

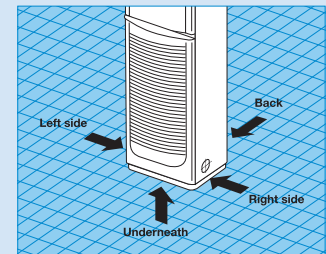

Streamlined, lightweight design

The PSY Series has a streamlined design and takes up very little floor space. Adding to this appeal, the unit weight has been significantly reduced for easier handling.

Long-life filter as standard equipment

Indoor units are equipped with a long-life filter that has a maximum service life of 2,500 hours* (based on use under average office conditions). Filter cleaning is drastically reduced. Furthermore, the adoption of an "open-and-close grille" makes it easy to take the filter out to clean off dust and particulates.

Adoption of "open-and-close grille" simplifies removal of filter for cleaning.

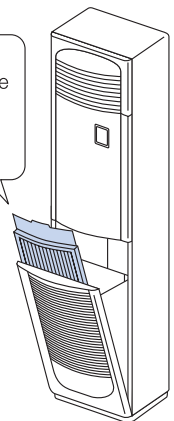

*May vary according to operating conditions.

Flockless vanes

With the adoption of new flockless vanes, dirt and other impurities can be cleaned off easily.

Features at a glance

Installation & Maintenance	Comfort	Others
• Chargeless system	• Auto-louver	• System control
• Lightweight design	• Computerized dehumidifier	• Auto restart
• 4-way multi-directional piping	• Quiet operation	• Outdoor unit max. operating temp. of 52°C
• Easily removable filter		
• Long-life filter (2500hrs.)*		
• Self-diagnostic function		
• Flockless vanes		

*May vary according to operating conditions.

SPECIFICATIONS

Floor-standing PSY SERIES

Models		PSY-SP36KA	PSY-SP42KA	PSY-SP48KA	
Cooling capacity (Min-Max)	kW	10.6 (4.0-10.6)	12.3 (6.1-12.3)	13.4 (6.7-13.4)	
	BTU/h	36,000	42,000	45,700	
Total input	kW	3.65	4.06	5.86	
EER	W/W	2.90	3.02	2.28	
ISEER	W/W	3.83	3.81	3.34	
Indoor unit	Model name	PSY-SP36KA	PSY-SP42KA	PSY-SP48KA	
	Power supply	1phase 220-240V 50Hz			
	External finish	Munsell 0.7Y 8.59/0.97			
	Airflow (low-med2-med1-high)	CMM	25-28-31		
		CFM	885-990-1090		
	External static pressure	Pa	0 (direct blow)		
	Operation control and thermostat	Built-in			
	Noise level (low-mid2-mid1-high)	dB (A)	45-49-51		
	Unit drain pipe (outer diameter)	mm	26		
	Dimensions	W	600		
		D	360		
		H	1,900		
	Weight	kg	48		
Outdoor unit	Model name	PUY-SP36YKA2	PUY-SP42YKA2	PUY-SP48YKA2	
	Power supply	3phase 380-415V 50Hz			
	External finish	Munsell 3.0Y 7.8/1.1			
	Refrigerant (R410A) control	Linear expansion valve			
	Airflow	CMM	75	87	
		CFM	2,648	3,071	
	Noise level	dB (A)	52	53	56
		W	1,050		
	Dimensions	D	330		
		H	981		
		Weight	kg	65	73
	Max. height difference	m	30		
	Max. piping length	m	50		
Pipe size (outer diameter)	mm	Liquid: 9.52 Gas: 15.88			
Guaranteed Operating Range	Upper limit (DB)	52			
	Lower limit (DB)	18			

- Rating conditions Cooling - Indoor: 27°C (80°F) DB, 19°C (66°F) WB, Outdoor: 35°C (95°F)
- Refrigerant piping length (one-way): 7.5m(25ft)
- Total input based on the indicated voltage (indoor/outdoor): 1phase 230V 50Hz, 3phase 400V 50Hz

CONTROL TECHNOLOGIES

Mr.SLIM

User-friendly Deluxe Remote Controller with Excellent Operability and Visibility

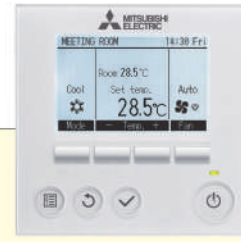

PAR-31MAA (Optional)

Full-dot Liquid-crystal Display Adopted

Easier to read thanks to use of a full-dot liquid-crystal display with backlight, and easier to use owing to the adoption of a menu format that enabled the number of operating buttons to be reduced.

Display Example [Operation Mode]

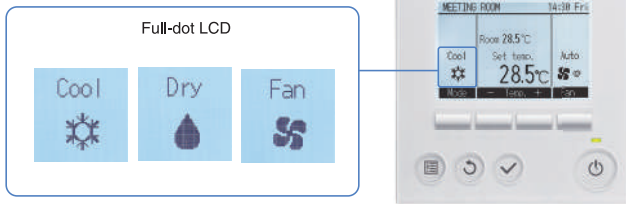

Easy-to-Read & Easy-to-Use

Multi-language

Multi-language Display

Control panel operation in eight different languages

Choose the desired language from among the following.



Energy-efficient Control

Operation Control Functions

Auto-return

Prevents wasteful operation by automatically returning to the preset temperature after specified operating time

After adjusting the initial temperature on a hot day, it is easy to forget to return the temperature setting to its original value. The Auto-return function automatically resets the temperature back to the original setting after a specified period of time, thereby preventing overcooling. The Auto-return activation time can be set in 10-minute units, in a range between 30 and 120 minutes.

*Auto-return cannot be used when Temperature Range Restriction is in use.

Night Setback

Keep desired room temperatures automatically

This function monitors the room temperature and automatically activates the cooling mode when the temperature rises above the preset maximum temperature setting.

Temperature Range Restriction

Temperature Range Restriction prevents overcooling

Using a temperature that is 1°C higher for cooling results in a 10% reduction in power consumption.* Temperature Range Restriction limits the maximum and minimum temperature settings, contributing to the prevention of overcooling. *In-house calculations

Cooling/Dry

(Setting example of minimum temp. at 25°C)

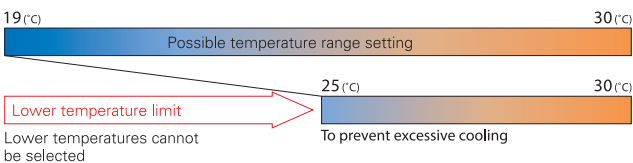

Recommended for Office Restaurant

Auto-off Timer

Turns cooling off automatically after preset time elapses

When using Auto-off Timer, even if one forgets to turn off the unit, operation stops automatically after the preset time elapses, thereby preventing wasteful operation. Auto-off Timer can be set in 10-minute units, in a range between 30 minutes and 4 hours. Eliminates all anxiety about forgetting to turn off the unit.

Recommended for Meeting room Changing room

Operation Lock

Fixed temperature setting promotes energy savings

In addition to operation start/stop, the operation mode, temperature setting and air-flow direction can be locked. Unwanted adjustment of temperature settings is prevented and an appropriate temperature is constantly maintained, leading to energy savings. This feature is also useful in preventing erroneous operation or tampering.

Recommended for Office School Public hall
Hospital Computer server facility

Weekly Timer

Set up to 8 patterns per day including temperature control

The Weekly Timer enables the setting of operation start and stop times and adjusting the temperature as standard features. Up to 8 patterns per day can be set, providing operation that matches the varying conditions of each period, such as the number of customers in the store. *Weekly Timer cannot be used when On/Off Timer is in use.

Setting Example (restaurant in summer time)

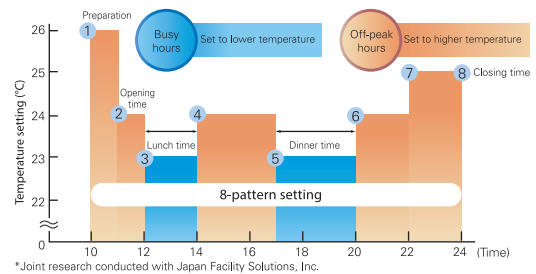

*Joint research conducted with Japan Facility Solutions, Inc.



PAR-21MAA (PEY-SP Series, PSY Series Built in)

Advanced MA Remote Controller – A Progressive Step in the Evolution of Air Conditioning Control

Dot Liquid-crystal Display Adopted

The adoption of dot liquid-crystal display (LCD) technology and a large display screen for the control panel optimise visibility. Operation and control status are easily read at a glance.

Display Example [Operation Mode]

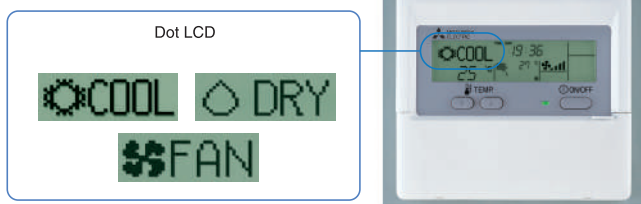

Easy-to-Read/Easy-to-Use

Multi-language

Multi-language Display

Control panel operation in eight different languages

Choose the desired language from among the following.



Energy-efficient Control

Operation Control Functions

Temperature Range Restriction

Air conditioner operation restricted to within a specified operating range

Set the upper and lower limits for the temperature range during operation. Excessive cooling is prevented, leading to increased energy savings.

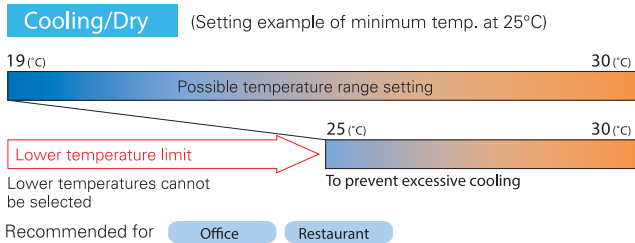

Auto-off Timer

Automatically turns off air conditioner

Set the time for the air conditioner to turn off automatically. The timer can be set in the range from 30 minutes up to 4 hours in 30-minute intervals. The "Simple Timer"—starts/stops in units of 1 hour in a 72-hour period—is set at the time of shipment from the factory. It can be changed to the "Auto-off Timer" function using the remote controller.

Recommended for Meeting room Changing room

Operation Lock

Prevent operation settings from being changed

Units can be set so that the operation mode cannot be changed. When "Operation Lock" is activated, new temperature setting commands are not accepted, thereby ensuring that the unit runs in the specified (locked in) temperature range. This promotes energy savings and prevents erroneous/mischievous operation. Only the administrator can change settings when using the Operation Lock mode.

Recommended for Office School Public hall
Hospital Computer server facility

Weekly Timer

Introduced in response to market demand

Control temperature on a weekly basis

Temperature settings and On/Off control can be managed over a period of one week using the Weekly Timer. Up to eight setting patterns per calendar day are possible.

Setting Example (restaurant in summer time)

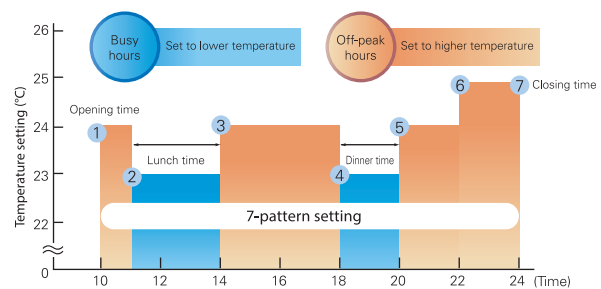

(Results of cooperative study with Japan Facility Solutions, Inc.)

NOTE & OUTDOOR UNIT

Notes for All Specifications

Rating conditions

Cooling - Indoor: 27°C (80°F) DB, 19°C (66°F) WB
Outdoor: 35°C (95°F) DB

Refrigerant piping length (one-way): 7.5m (25ft)

Total input based on the indicated voltage (indoor/outdoor)

50Hz	Indoor Single-phase, 220-240V	Outdoor	
		18/24/30V Single-phase, 220-240V	36/42/48Y Three-phase, 380-415V

Guaranteed Operating Range

		SUY-SA	PUY-SP
Cooling	Upper limit (DB)	52°C	52°C
	Lower limit (DB)	18°C	18°C

Sound Pressure Level

- Sound pressure measurements were conducted in an anechoic chamber.
- The actual noise level depends on the distance from the unit and the acoustic environment.

Refrigerant Piping

Capacity	Between indoor and outdoor units		Pipe size (mm, outer dia.)	Thickness (mm)
	Max. height difference (m)	Max. piping length (m)		
SUY-SA18	12	20	Liquid: ø6.35 Gas: ø12.7	t 0.8
SUY-SA24/30	15	30	Liquid: ø9.52 Gas: ø15.88	t 0.8 t 1.0
PUY-SP36 PUY-SP42 PUY-SP48	30	50	Liquid: ø9.52 Gas: ø15.88	t 0.8 t 1.0

Refrigerant Requirements (R410A: kg)

Piping length	Factory charged		Additional charge								Calculation
	7m	10m	15m	20m	25m	30m	35m	40m	45m	50m	
SUY-SA18	1.2	0.05	0.12	0.2	—	—	—	—	—	—	Xg=15g/m x (length-7)m
SUY-SA24	2.0	0.06	0.16	0.26	0.36	0.46	—	—	—	—	Xg=20g/m x (length-7)m
SUY-SA30	2.1	0.06	0.16	0.26	0.36	0.46	—	—	—	—	Xg=20g/m x (length-7)m
PUY-SP36 PUY-SP42 PUY-SP48	2.8	0	0.15	0.30	0.45	0.60	0.75	0.90	1.05	1.20	Xg=30g/m x (length-10)m

• When installing a single outdoor unit

<S Series>

- SUY-SA18

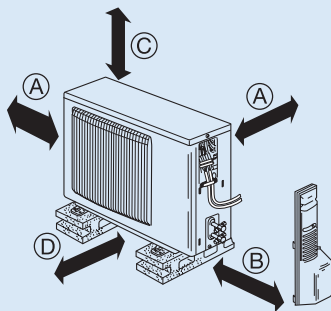

- SUY-SA24
- SUY-SA30

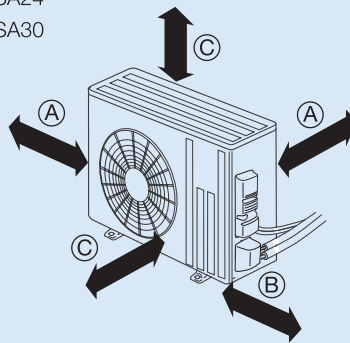

<P Series>

- PUY-SP36
- PUY-SP42
- PUY-SP48

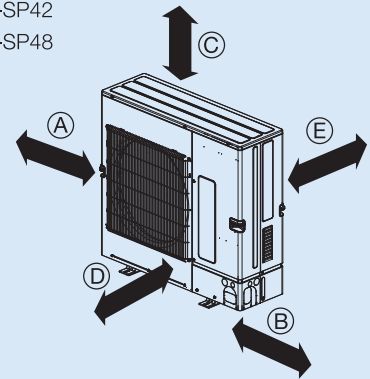

	SUY-SA18	SUY-SA24, 30
(A)	100mm or more	100mm or more
(B)	350mm or more	350mm or more
(C)	100mm or more	500mm or more
(D)	200mm or more	—

	PUY-SP36,42,48
(A)	250mm or more
(B)	250mm or more
(C)	1,500mm or more
(D)	Free
(E)	500mm or more

[Notice] If there is any obstruction around the unit, check the condition details in the Data Book.

OPTIONAL PARTS

Optional Parts

Part Name	Model name	Applicable models	
Drain pump	PAC-DRP06SL-E	PEY-SP	
M-NET and Terminal interface	MAC-334IF-E	All indoor units	
Wireless remote controller	PAR-SL100A-E	PLY-SP-EA	
	PAR-SL97A-E	PLY-SP / PEY-SP	
Wireless remote controller signal receiver	PAR-SA9CA-E	PEY-SP	
	PAR-SE9FA-E	PLY-SP-EA	
	PAR-SA9FA	PLY-SP-BA	
High-efficiency filter element	PAC-SH59KF-E	PLY-SP	
Filter box	PAC-KE92TB-E	PEY-SP18	
	PAC-KE93TB-E	PEY-SP24	
	PAC-KE94TB-E	PEY-SP30/36/42/48	
3D i-see sensor corner panel	PAC-SE1ME-E	PLY-SP-EA	
i-see sensor corner panel	PAC-SA1ME-E	PLY-SP-BA	
Shutter plate	PAC-SJ37SP-E	PLY-SP-EA	
	PAC-SH51SP-E	PLY-SP-BA	
Remote On/Off adaptor	PAC-SE55RA-E	All indoor units	
Remote operation adaptor	PAC-SF40RM-E	All indoor units	
Remote sensor	PAC-SE41TS-E	All indoor units	
Space panel	PAC-SJ65AS-E	PLY-SP-EA	
	PAC-SH48AS-E	PLY-SP-BA	
Connector cable for remote display	PAC-SH48AS-E	All indoor units	
Wired remote controller	PAR-32MAA	All indoor units	
	PAR-21MAA	All indoor units	
Multiple remote controller adaptor	PAC-725AD	All indoor units	
Air outlet guide	MAC-881SG	SUY-SA18	
	MAC-886SG-E	SUY-SA24/30	
	PAC-SH96SG-E	PUY-SP36/42/48	
Joint pipe	(Unit ø9.52 → Pipe ø12.7)	PAC-SG73RJ-E	PUY-SP36/42/48
	(Unit ø15.88 → Pipe ø19.05)	PAC-SG75RJ-E	PUY-SP36/42/48
Filter dryer for liquid pipe	PAC-SG82DR-E	PUY-SP36/42/48	
Air protection guide	PAC-SH95AG-E	PUY-SP36/42/48	
Drain socket	PAC-SG61DS-E	PUY-SP36/42/48	
Centralized drain pan	PAC-SH97DP-E	PUY-SP36/42/48	
M-Net converter	PAC-SJ95MA-E	PUY-SP36/42/48	
Control/Service tool	PAC-SK52ST	PUY-SP36/42/48	
External Input adapter	PAC-SC36NA-E	PUY-SP36/42/48	
Power supply terminal kit	PAC-SJ39HR-E	PLY-SP36/42/48-EA	

⚠ CAUTION

- Do not install indoor units in areas where the emission of VOCs such as phthalate compounds and formaldehyde is known to be high (e.g., mobile phone base stations) as this may result in a chemical reaction.
- When installing, relocating or servicing air conditioners, use only the specified refrigerant (R410A) to charge the refrigerant lines. Do not mix R410A with any other refrigerant and do not allow air to remain in the lines. If air is mixed with the refrigerant, this may cause abnormal high pressure in the refrigerant lines and possibly result in an explosion or other hazard.
The use of any refrigerant other than that specified for the system will cause mechanical failure, system malfunction or unit breakdown. In the worst case, it could lead to a serious impediment to securing product safety.

OPTIONAL PARTS

Main Optional Parts

Part name	Description
High-efficiency Filter Element Element for high-efficiency filter. Removes fine dust particles from the air.	<p>Plug (for directing airflow) High-efficiency filter element</p> <p>*For 4-way cassette units (PLY)</p>
i-see sensor and (3D) i-see sensor for corner panel for PLY Corner panel holding the (3D) i-see Sensor.	<p>i-see Sensor corner panel</p>
Shuttle Plate Plate for blocking an air outlet of the 4-way cassette indoor unit.	<p>Shuttle Plate</p>
Space Panel Decorative cover for installation when the ceiling height is low.	<p>Space Panel Panel</p>
Wired Remote Controller Advanced deluxe remote controller with full-dot liquid-crystal display and backlight. Equipped with convenient functions like night-setback.	
Remote Sensor Sensor to detect the room temperature at remote positions.	<p>Remote sensor</p>
Drain Pump for PEY Series Raises drain generated during units operation to secure the appropriate angle of the drain pipe.	
Power Supply Terminal Kit Terminal bed to change the power supply from outdoor power supply to separate indoor/ outdoor power supplies.	

Part name	Description
Remote On/Off Adapter Connector for receiving signals from the local system to control the on/off function.	<p>Remote on/off adapter</p>
Connector Cable for Remote Display Connector used to display the operation status and control the on/off function from a distance.	<p>Connector cable for remote display</p> <p>Brown Red Orange Yellow Green</p>
Joint Pipe Part for connecting refrigerant pipes of different diameters.	<p>Indoor unit Joint pipe Onsite pipe Insulator Outdoor unit</p>
Air Outlet Guide Changes the direction of air being exhausted from the outdoor unit.	
Air Protection Guide Protects the outdoor unit from the wind.	
Drain Socket A set of caps to cover unnecessary holes at the bottom of the outdoor unit, and a socket to guide drain water to the local drain pipe.	<p>Cap Drain socket</p>
Centralised Drain Pan Catches drain water generated by the outdoor unit.	<p>Outdoor unit Centralised drain pan Base (local construction)</p>
M-NET Converter Used to connect P Series A-control models to M-NET controllers.	<p>Group remote controller Power supply unit for transmit cable M-NET Converter</p>
Control/Service Tool Monitoring tool to display operation and self-diagnosis data.	<p>Control/service tool</p>

The MEQ Difference



Simply meeting industry standards, however stringent, is not enough. Our aim is to exceed them. When it comes to comfort, efficiency and durability, Mitsubishi Electric offers you a distinctive advantage. We call it MEQ — Mitsubishi Electric Quality. It results in benchmark leading-edge products like our air conditioners, which consume minimal power, protect your investment through a long service life, offer superior reliability and are built to take the punishment of extreme weather conditions year in and year out.

Mitsubishi Electric Offers Three Important Advantages

Comfort

Clean air, optimum temperature distribution and silent operation...

MEQ has led to the development of state-of-the-art air purification and deodorization filters that remove unwanted odors and impurities in the air. Original airflow technologies and specially designed components provide even temperature distribution — even in remote regions of a room. At Mitsubishi Electric, comfort doesn't simply mean cool or warm, it means clean and quiet too.

Efficiency

Optimum cost performance and energy savings...





MEQ results in air conditioners that are rated among the best in the industry in terms of quality and energy efficiency. We strive for a perfect balance of performance, reliability, low power consumption and long service life. This is complemented by continuously introducing new technologies and components that further reduce energy requirements and negative environmental impact.

Durability

Rugged construction, rigorous testing, long-lasting operation...

MEQ is behind a mindset that goes to extremes to ensure higher quality products that protect the initial investment over years of reliable service. We subject our indoor and outdoor units to rigorous durability testing, including harsher temperature extremes than likely found anywhere in the world.



-  **Head Office**
-  **Branch Offices**
-  **Satellite Offices**
-  **Technical Centres**
-  **Sales Offices**

*Map for reference purpose only.

MITSUBISHI ELECTRIC INDIA PVT. LTD.

HEAD OFFICE: 3rd Floor, Tower A, Global Gateway, MG Road, Gurugram – 122002 (Haryana)

Tel. No.: (Main): 0124-6739300/301 **Website:** www.MitsubishiElectric.in **Email:** customersupport@asia.meap.com

Customer Care Toll Free No.: 1800 102 2626

TECHNICAL CENTRES: Ahmedabad: 079-67777874; Bengaluru: 080-40201600; Chennai: 044-49232222;
Delhi: 011-66057900; Mumbai: 022-66116200

BRANCH/SALES OFFICES: Ahmedabad: 079-67777888; Bhubaneswar: 09073949597; Bengaluru: 080-40201600;
Coimbatore: 0422-4385606; Chandigarh: 0172-4601645; Chennai: 044-49232222; Delhi: 011-66057900;
Ghaziabad: 011-66057900; Hyderabad: 040-43438888; Indore: 0731-4098991; Jaipur: 0141-4011109;
Kolkata: 033-40858800/16-88; Kochi: 0484-4862093; Lucknow: 0522-4002607; Ludhiana: 0161-4061654;
Mumbai: 022-66116200; Nagpur: 09921442323; Pune: 09922441773; Rajkot: 09586605009;
Surat: 0261-4003111; Vadodara: 0265-2314699; Vijaywada: 08498894567.

SATELLITE OFFICES: Agra: 09536900140; Amritsar: 09780021037; Aurangabad: 09552572820;
Bhopal: 08448398010; Dehradun: 08800878763; Goa: 09167113443; Hubli: 08448398010; Kanpur: 07755007767;
Patna: 09073949596; Raipur: 08448397997; Ranchi: 0973949598; Tirupati: 09319591931; Trichy: 09205599022;
Varanasi: 09336311110; Vizag: 09205987308



"For E-waste Collection & Disposal process: Customer can get complete details of company process on collection, disposal of e-waste product (i.e. 'Mitsubishi Electric' make Air Conditioner) and incentive / exchange scheme for returning of e-waste on **Company website (www.MitsubishiElectric.in)** or by calling on **Toll free number 1800 102 2626**.

